

SHAPES OF LINEAR LIGHTING

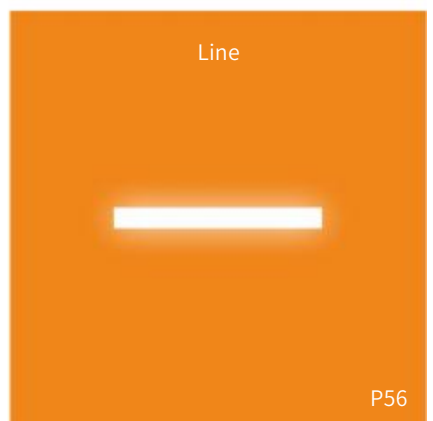

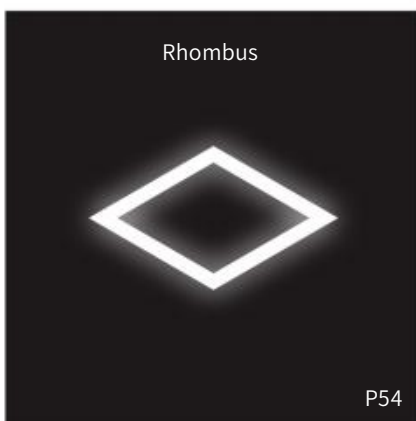
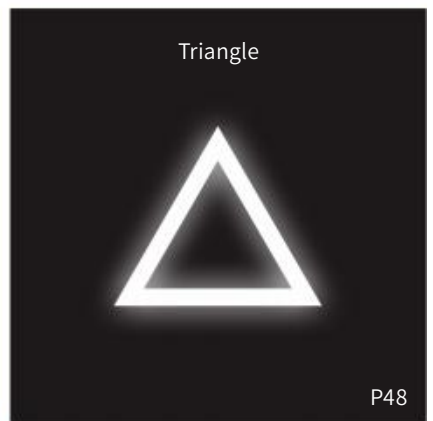
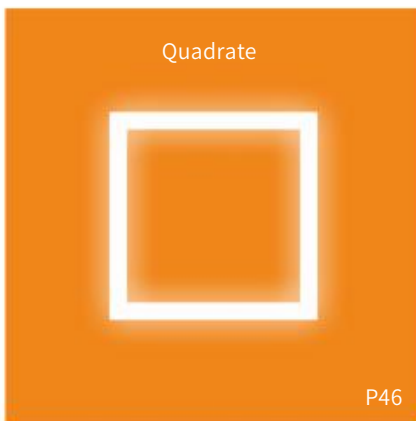
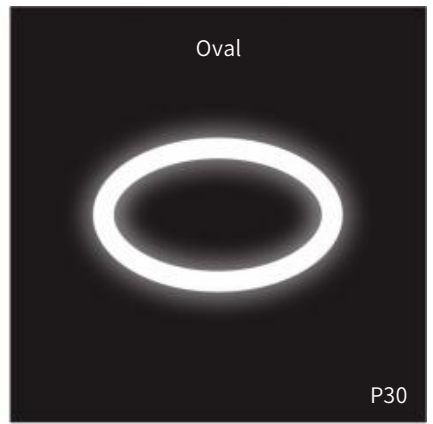
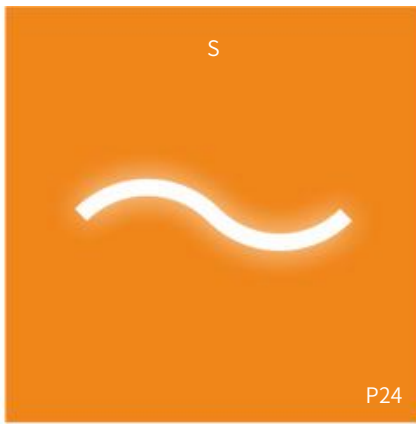
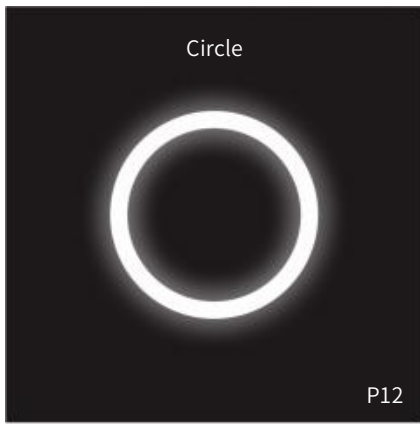

Wire Holder

Ceiling box

Hanging

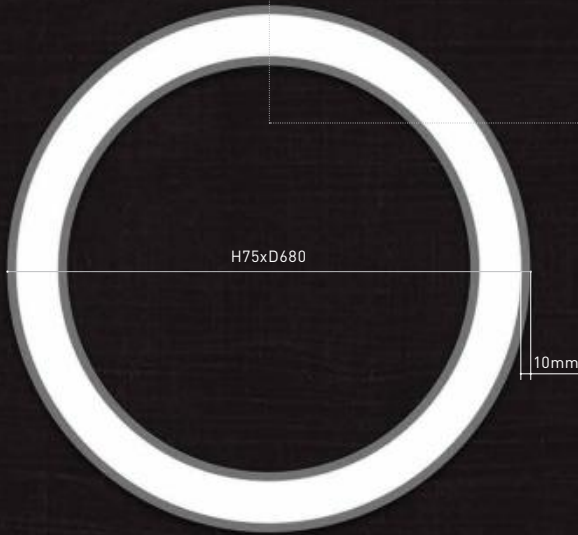
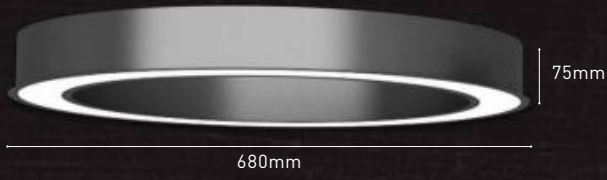

Model series

LRXX35 LRXX75

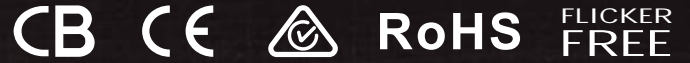

Accessories

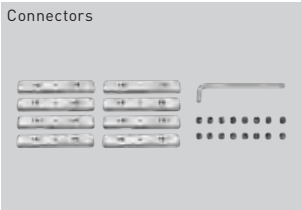
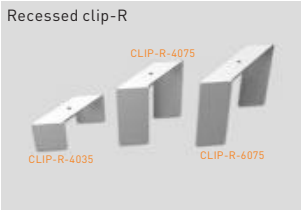

Optical parameters

Full spectrum test report

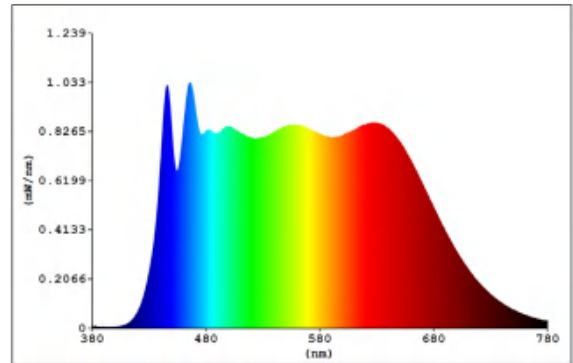

*@4000K, CRI>95, lower blue wave power

IES test report

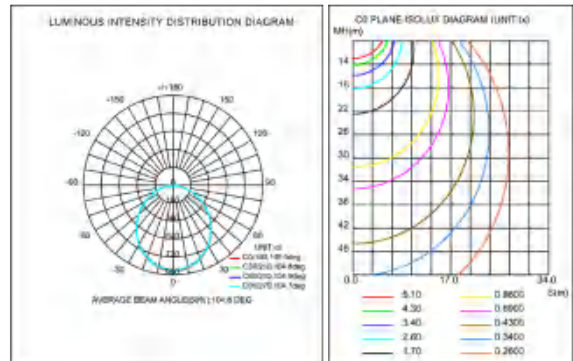



Recessed

Ceiling box

Terminal box

Aluminum bar

Wall/Ceiling

H60xW353xL2165

Product width:353mm

Height

Width

Model series

LCXX60

LCXX80

LRXX35

LRXX75

Eg: LC6060-S-2165

Profile width

Profile height

S series

Product length

Product length:2165mm



Accessories

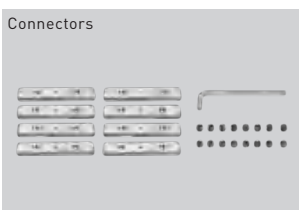
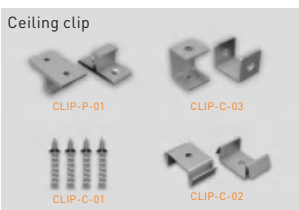
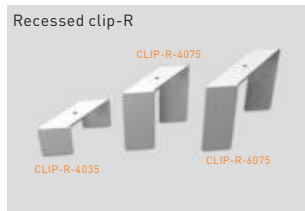

Optical parameters

Full spectrum test report

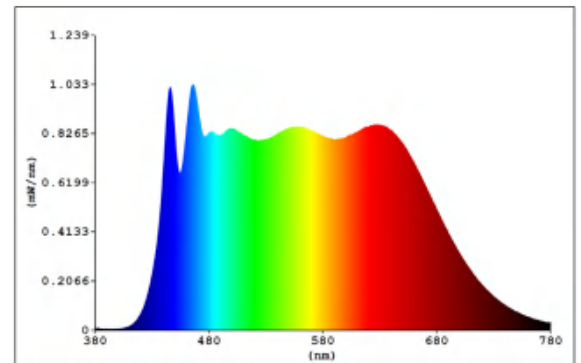

*@4000K, CRI>95, lower blue wave power

IES test report

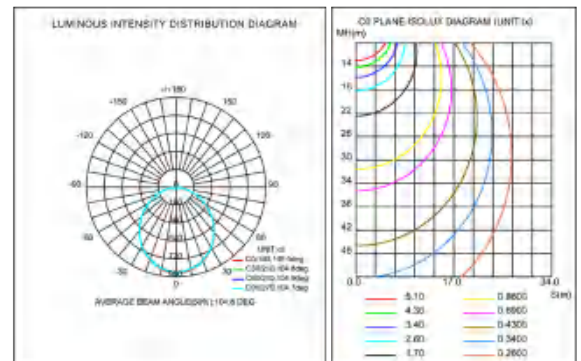

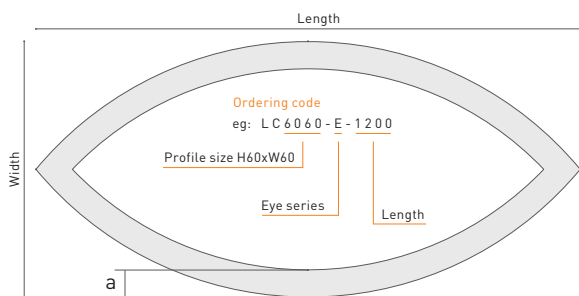
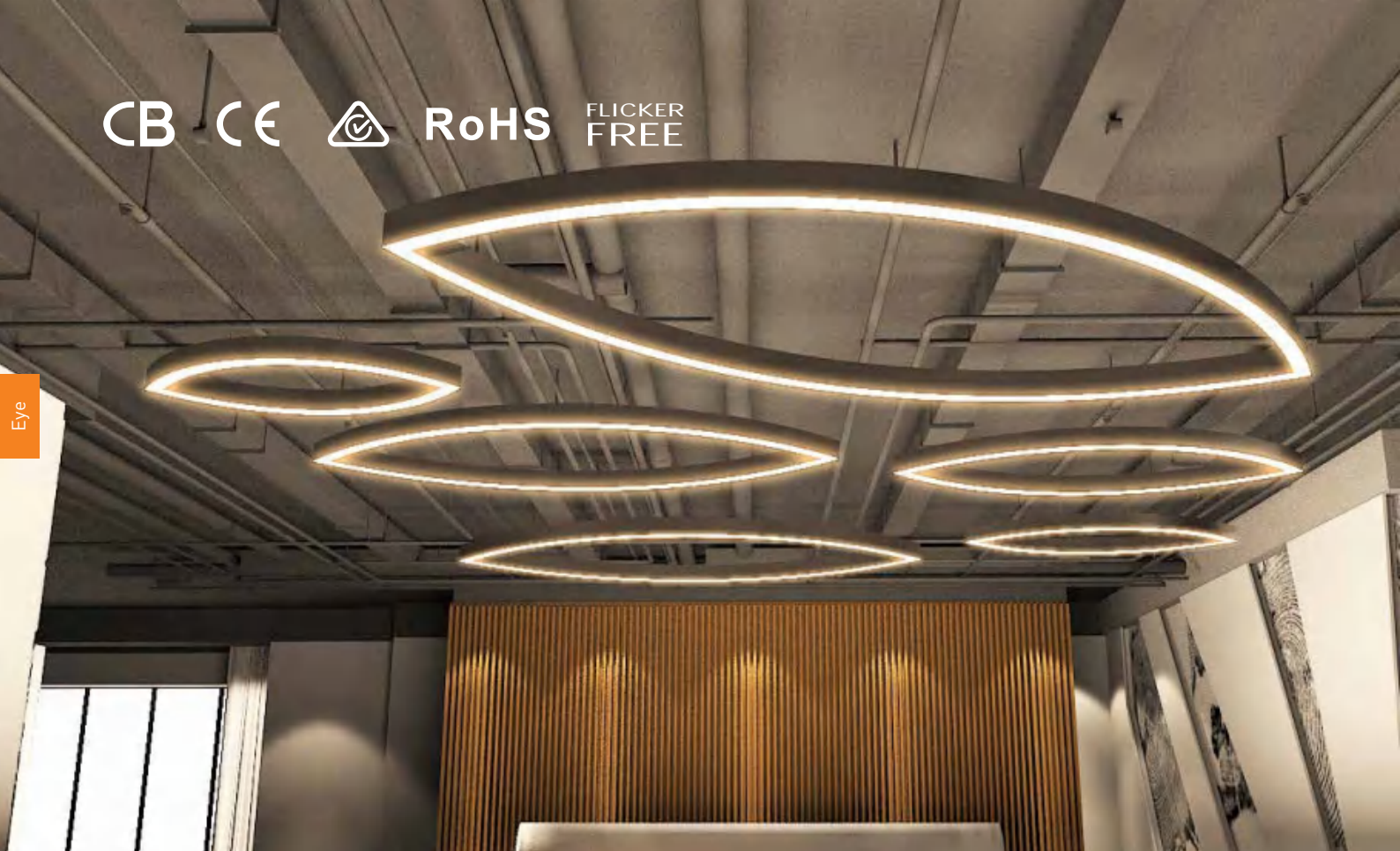

Case 1: if the length < 1.5m, profile is only 1 part

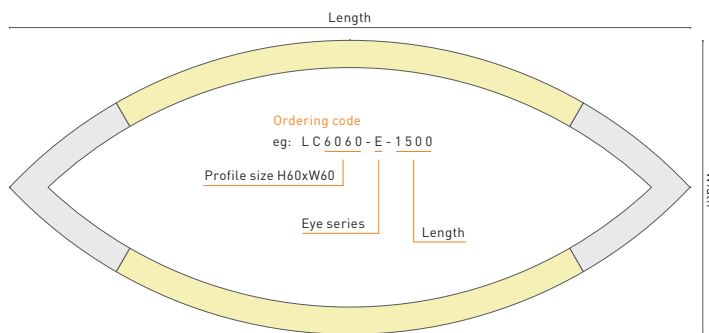

Case 2: if the length ≥ 1.5m, profile is connected by parts.

Accessories

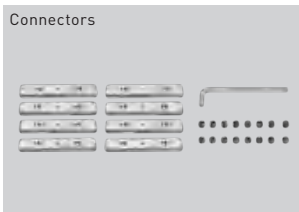
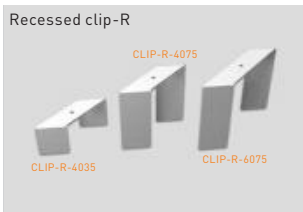
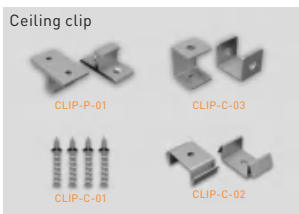

a/mm
40
50
60
70
80
90
100
110
120
150

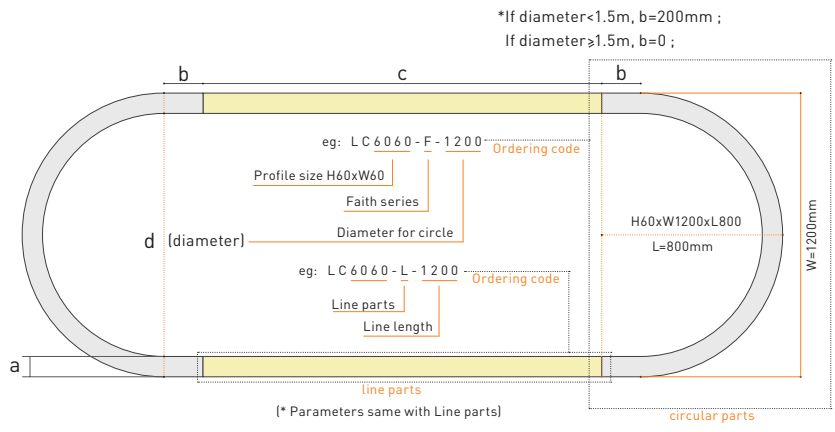

Accessories

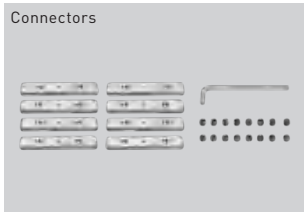
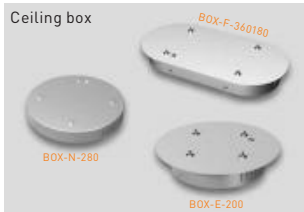
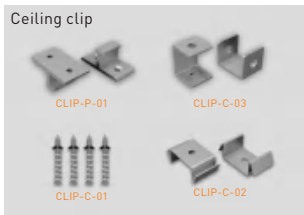

a/mm	d/mm	c/mm	b/mm
	450	900	
40	660	1000	
50	900	1100	
60	1060	1200	
70	1200	1300	
80	1560	1400	
90	1860	1500	0
100	2060	1600	200
110	2460	1700	
120	3060	1800	
150	4060	1900	
	5060	2000	
	6060	2200	
	7060	2400	

CB CE  RoHS FLICKER FREE

Belief



Sections

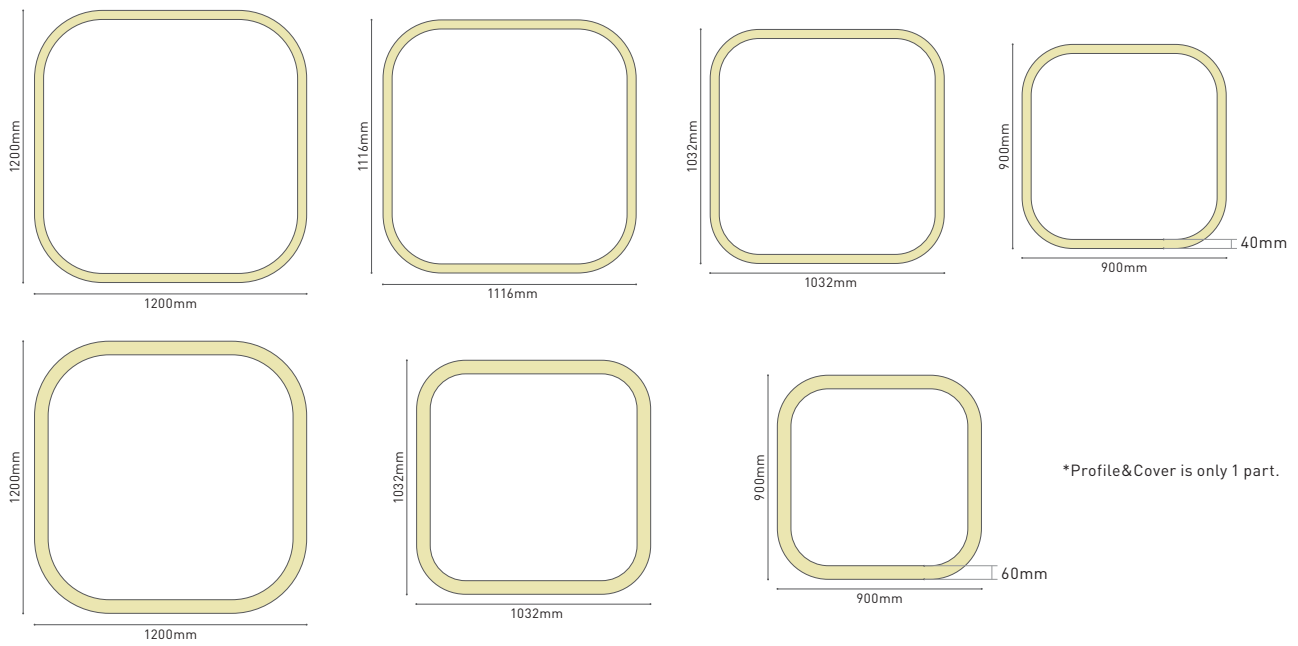

Ordering code for Belief series

*Lumens @4000K, CRI 80

Model	Item	Size/mm	Power/W 1 pcs	Lumens /lm	Dimming	CCT	CRI	Input /VAC	Color	Certification
LCXX60	LC4060-B-900	H60xW900xL900	20	2000	Non Dali Triac 0-10V Tunable	3000K 4000K 6000K	>80 >90 >95	200-240 100-277	White Black Silver Gold	CE CB SAA RCM RoHS
	LC4060-B-1032	H60xW1032xL1032	25	2500						
	LC4060-B-1116	H60xW1116xL1116	35	3500						
	LC4060-B-1200	H60xW1200xL1200	40	4000						
	LC6060-B-900	H60xW900xL900	50	5000						
	LC6060-B-1032	H60xW1032xL1032	60	6000						
	LC6060-B-1200	H60xW1200xL1200	70	7000						
LCXX80	LC4080-B-900	H80xW900xL900	20	2000	Non Dali Triac 0-10V Tunable	3000K 4000K 6000K	>80 >90 >95	200-240 100-277	White Black Silver Gold	CE CB SAA RCM RoHS
	LC4080-B-1032	H80xW1032xL1032	25	2500						
	LC4080-B-1116	H80xW1116xL1116	35	3500						
	LC4080-B-1200	H80xW1200xL1200	40	4000						
	LC6080-B-900	H80xW900xL900	50	5000						
	LC6080-B-1032	H80xW1032xL1032	60	6000						
	LC6080-B-1200	H80xW1200xL1200	70	7000						
LCXX100	LC60100-B-900	H100xW900xL900	50	5000	Non Dali Triac 0-10V Tunable	3000K 4000K 6000K	>80 >90 >95	200-240 100-277	White Black Silver Gold	CE CB SAA RCM RoHS
	LC60100-B-1032	H100xW1032xL1032	60	6000						
	LC60100-B-1200	H100xW1200xL1200	70	7000						

Accessories





Case 1: if the diameter < 1.5m; b = 200mm

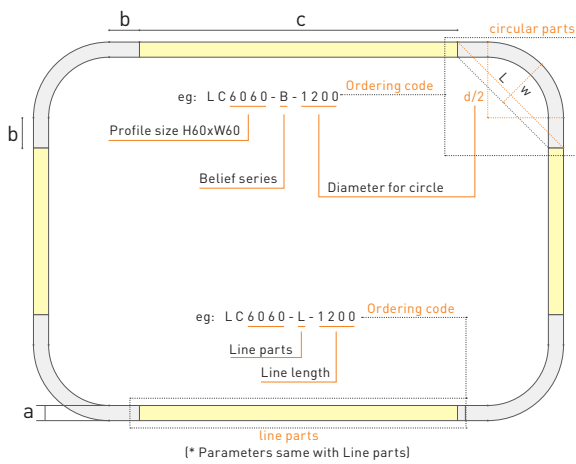

Case 2: if the diameter ≥ 1.5m; b = 0

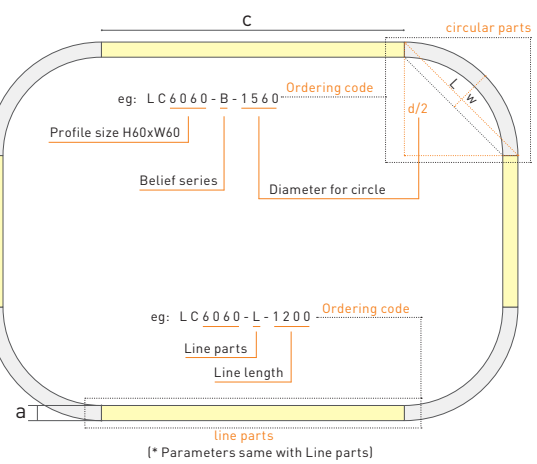

Accessories

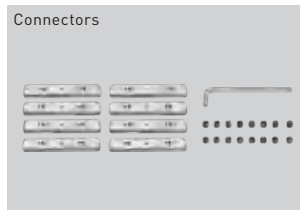
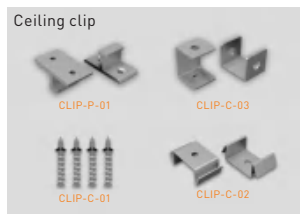

a/mm	d/mm	c/mm	b/mm
	450	900	
40	660	1000	
50	900	1100	
60	1060	1200	
70	1200	1300	
80	1560	1400	0
90	1860	1500	
100	2060	1600	200
110	2460	1700	
120	3060	1800	
150	4060	1900	
	5060	2000	
	6060	2200	
		2400	



Case 1: if the length < 1.5m, profile is only 1 part

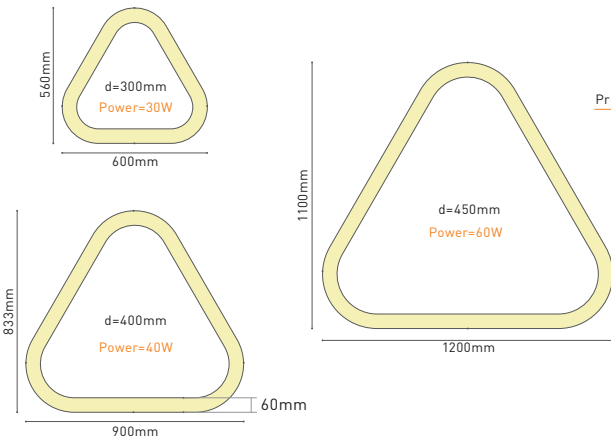

Case 2: if the length > 1.5m, profile is connected by parts

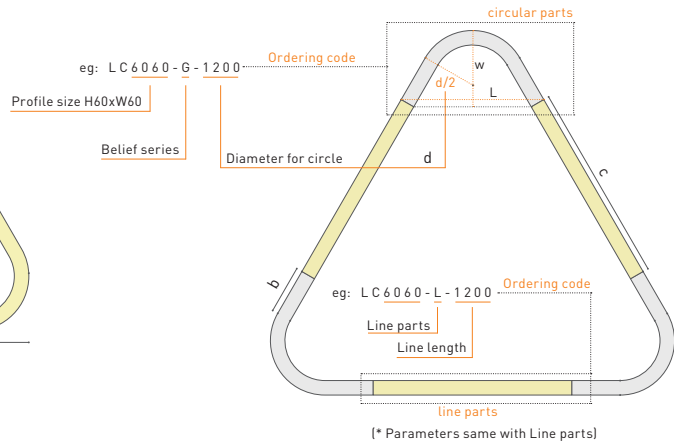

Accessories

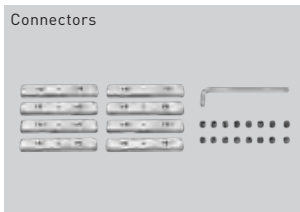
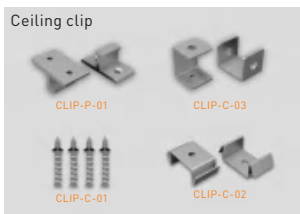

a/mm	d/mm	c/mm	b/mm
		900	
40	300	1000	
50	400	1100	
60	450	1200	
70	600	1300	
80	660	1400	
90	680	1500	
100	740	1600	
110	900	1700	
120	1000	1800	
150	1060	1900	
	1200	2000	
		2200	200
		2400	



Quadrato

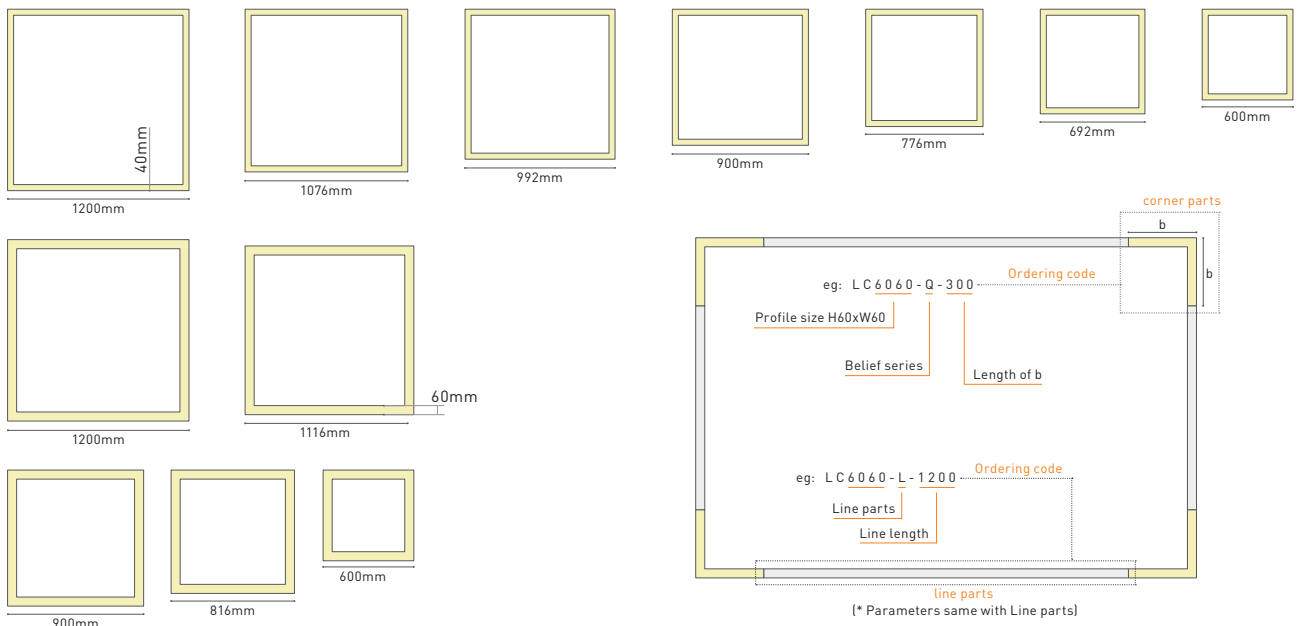

Accessories

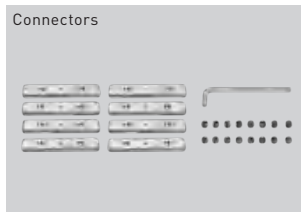
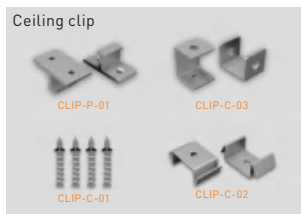

a/mm	b/mm	c/mm
		900
40		1000
50		1100
60		1200
70		1300
80	300	1400
90	400	1500
100		1700
110		1800
120		1900
150		2000
		2200
		2400

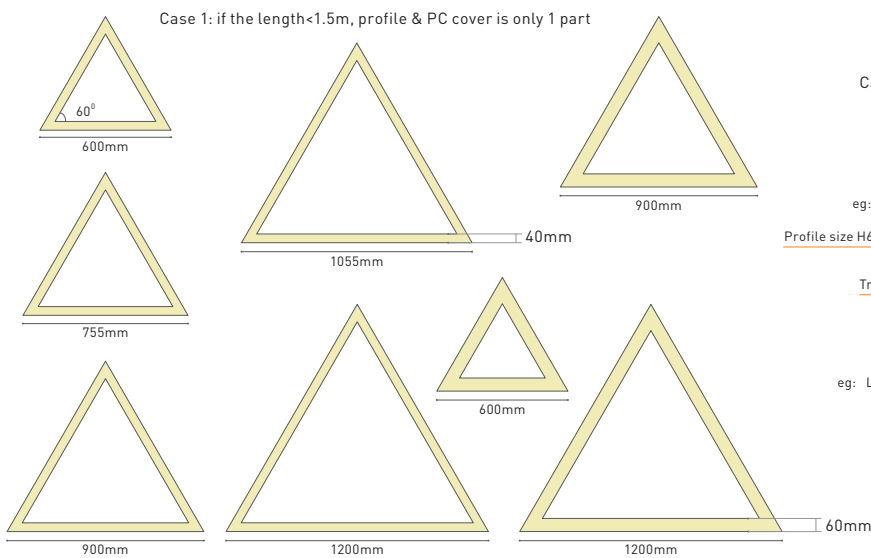
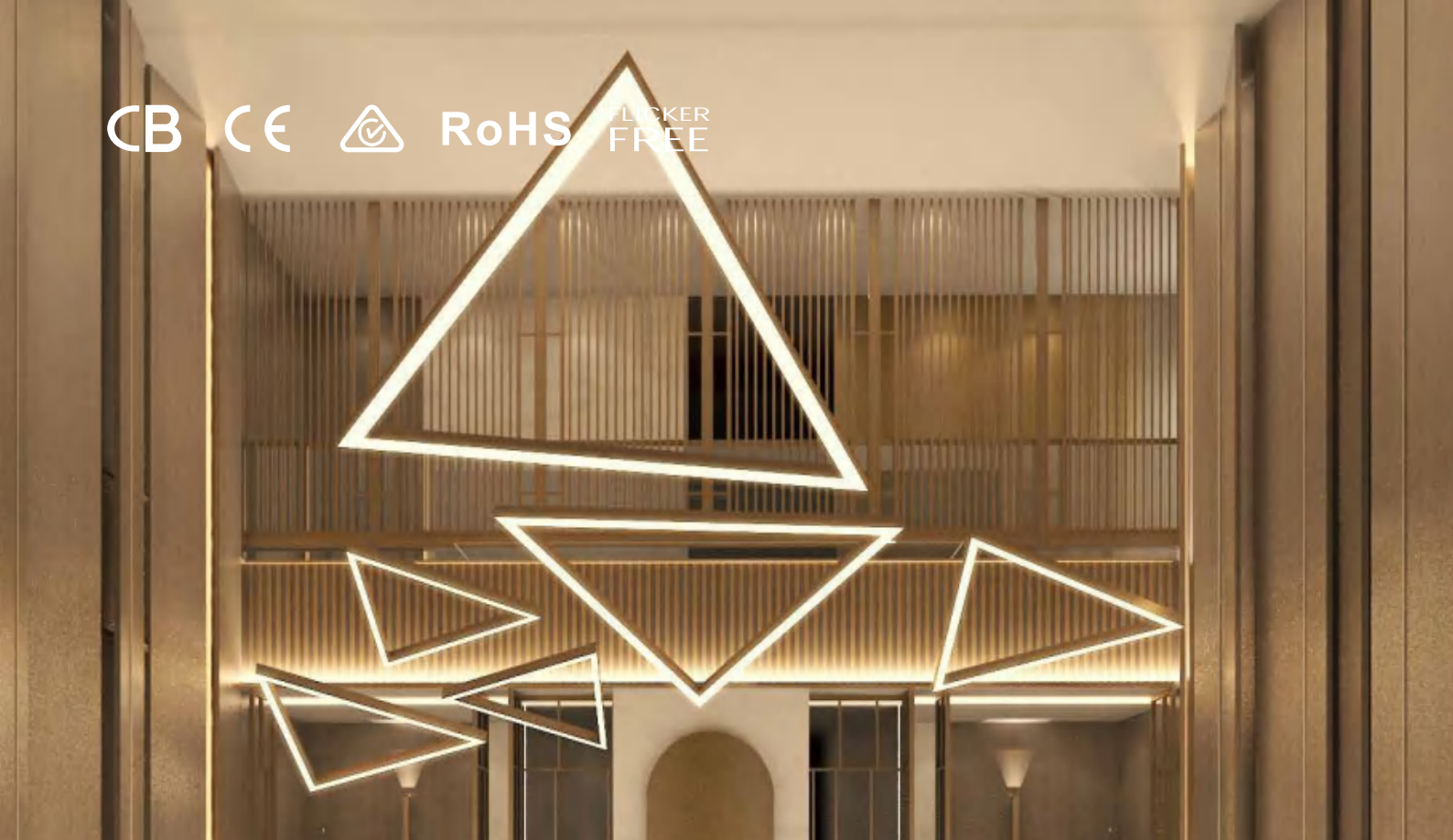

Case 2: if the length > 1.5m, profile is connected by parts.

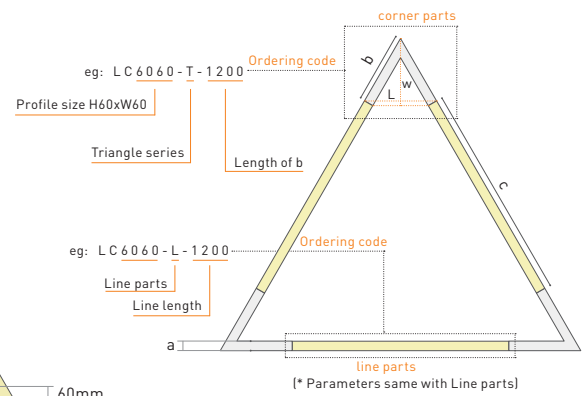

Accessories

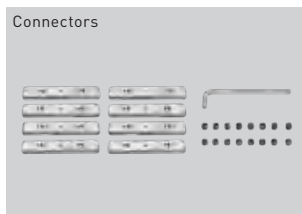
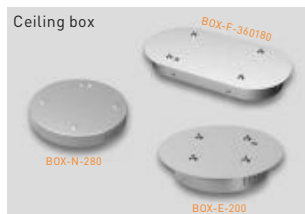
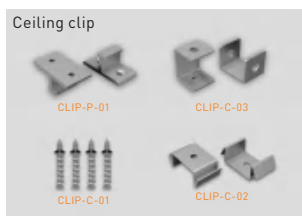

a/mm	b/mm	c/mm
		900
40		1000
50		1100
60		1200
70		1300
80	300	1400
90	400	1500
100		1700
110		1800
120		1900
150		2000
		2200
		2400

CB CE  RoHS FLICKER FREE

Hexagon

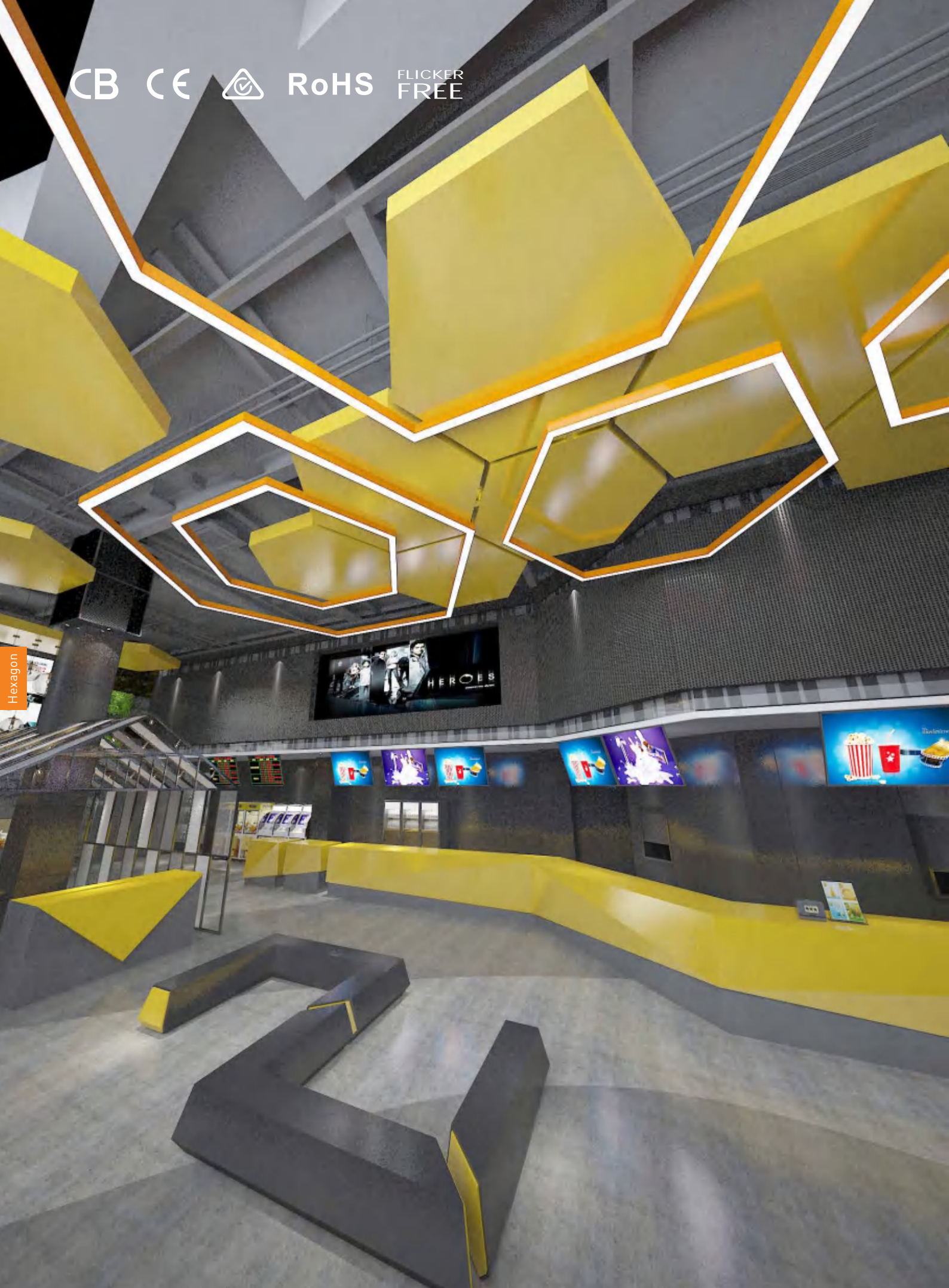

Sections

Case 1: if the length < 1.5m, profile & PC cover is only 1 part

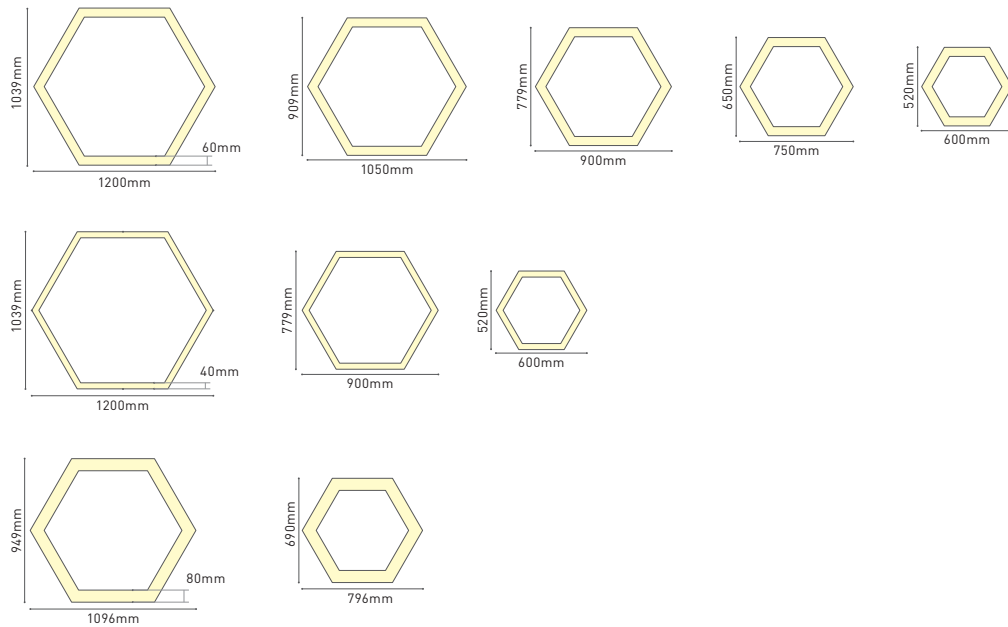

Ordering code for Hexagon series - < 1.5M

*Lumens @4000K, CRI 80

Model	Item	Size/mm	Power/W 1 pcs	Lumens /lm	Dimming	CCT	CRI	Input /VAC	Color	Certification
LCXX60	LC4060-H-600	H60xW520xL600	13	1300	Non Dali Triac 0-10V Tunable	3000K 4000K 6000K	>80 >90 >95	200-240 100-277	White Black Silver Gold	CE CB SAA RCM RoHS
	LC4060-H-900	H60xW779xL900	17	1700						
	LC4060-H-1200	H60xW1039xL1200	20	2000						
	LC6060-H-600	H60xW520xL600	25	2500						
	LC6060-H-750	H60xW650xL750	30	3000						
	LC6060-H-900	H60xW779xL900	30	3000						
	LC6060-H-1050	H60xW909xL1050	45	4500						
	LC6060-H-1200	H60xW1039xL1200	60	6000						
	LC8060-H-796	H60xW690xL796	60	6000						
LC8060-H-1096	H60xW949xL1096	80	8000							
LCXX80	LC4080-H-600	H80xW520xL600	13	1300	Non Dali Triac 0-10V Tunable	3000K 4000K 6000K	>80 >90 >95	200-240 100-277	White Black Silver Gold	CE CB SAA RCM RoHS
	LC4080-H-900	H80xW779xL900	17	1700						
	LC4080-H-1200	H80xW1039xL1200	20	2000						
	LC6080-H-600	H80xW520xL600	25	2500						
	LC6080-H-750	H80xW650xL750	30	3000						
	LC6080-H-900	H80xW779xL900	30	3000						
	LC6080-H-1050	H80xW909xL1050	45	4500						
	LC6080-H-1200	H80xW1039xL1200	60	6000						
	LC8080-H-796	H80xW690xL796	60	6000						
LC8080-H-1096	H80xW949xL1096	80	8000							
LCXX100	LC60100-H-600	H100xW520xL600	25	2500						
	LC60100-H-900	H100xW779xL900	30	3000						
	LC60100-H-1200	H100xW1039xL1200	60	6000						



CB CE  RoHS FLICKER FREE

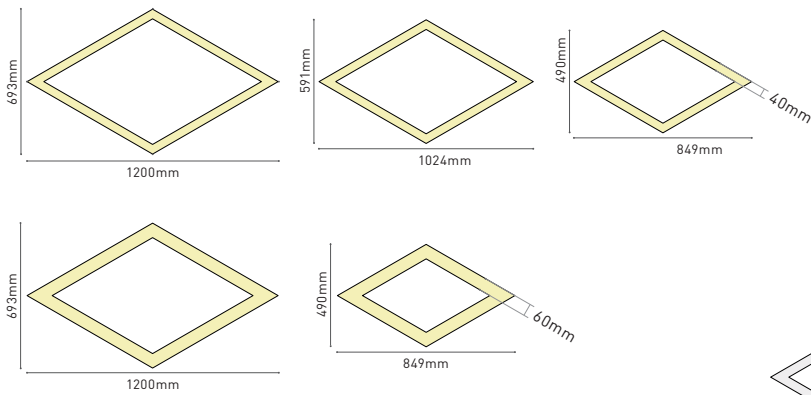

Case 1: if the length < 1.5m, profile & PC cover is only 1 part.

Case 2: if the length ≥ 1.5 m, profile is connected by parts.

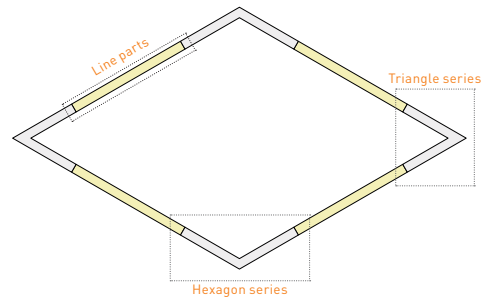

Accessories

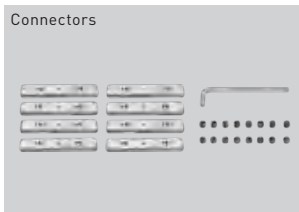
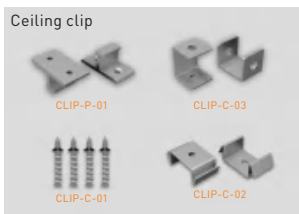

a/mm	b/mm	c/mm
		900
40		1000
50		1100
60		1200
70		1300
80	300	1400
90	400	1500
100		1600
110		1700
120		1800
150		1900
		2000
		2200
		2400